

NETWORK ON CHIPS

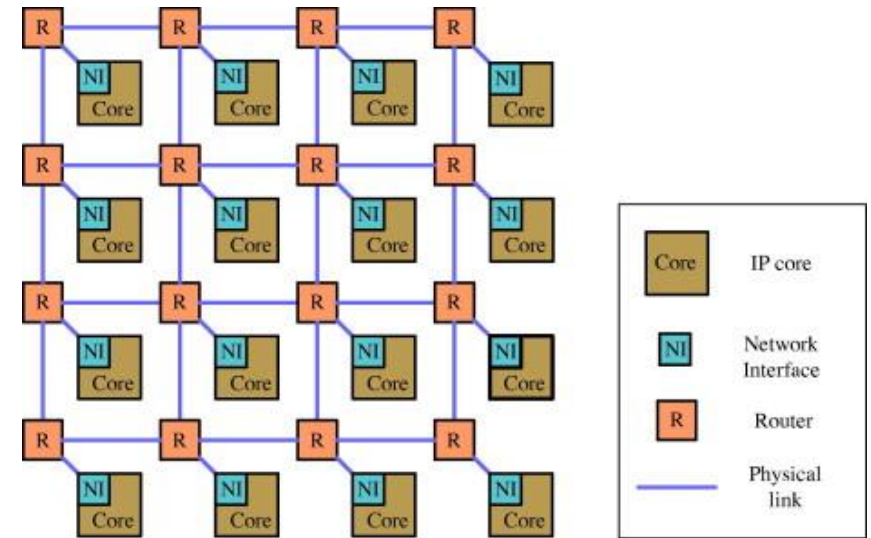

WHAT IS NETWORK ON CHIPS?



MY PROJECT



BASIC APPROACH



ANALOGY TIME



HANDSHAKING PROCESS

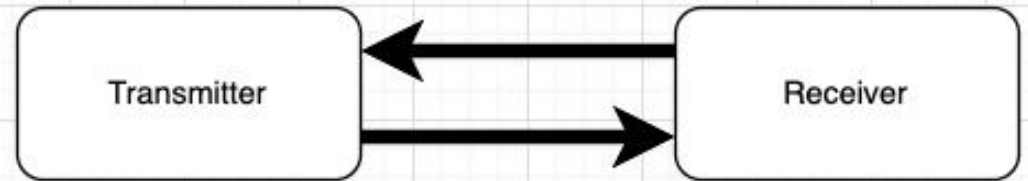

ANALOGY TIME



TRANSMITTER

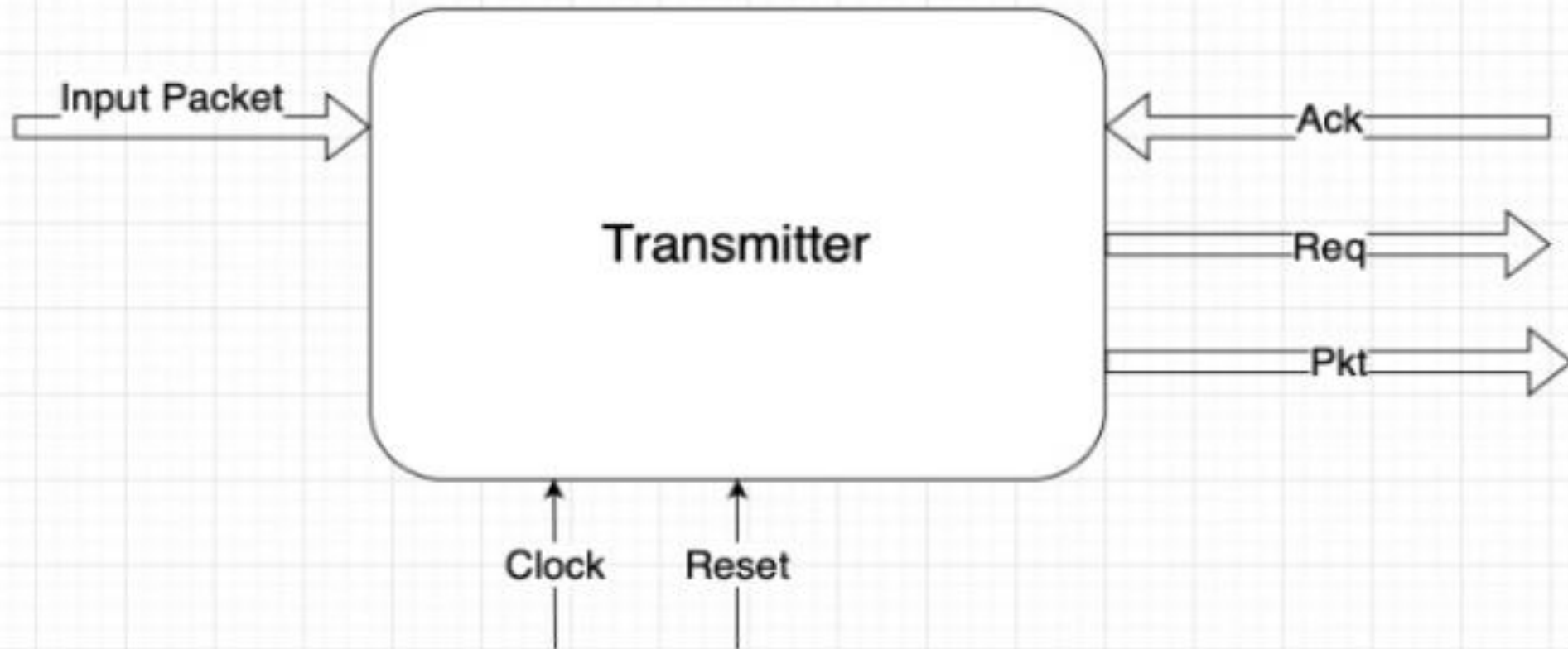

RECEIVER

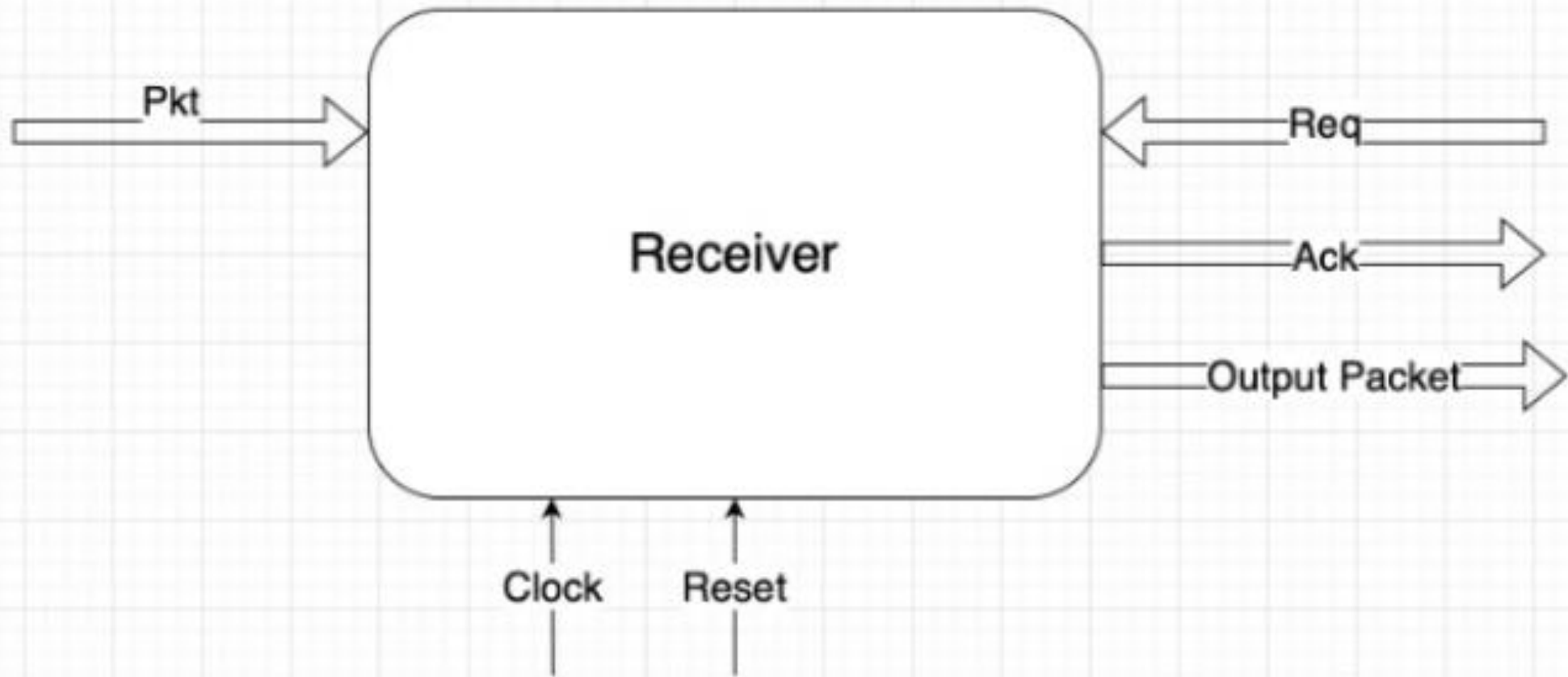



CURRENT LIMITATION





GIVE AND
TAKE

SOLUTION

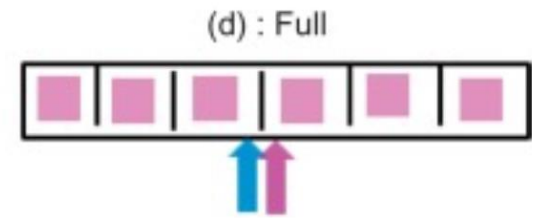
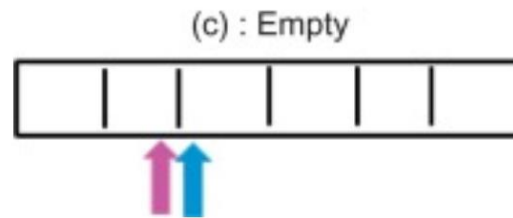
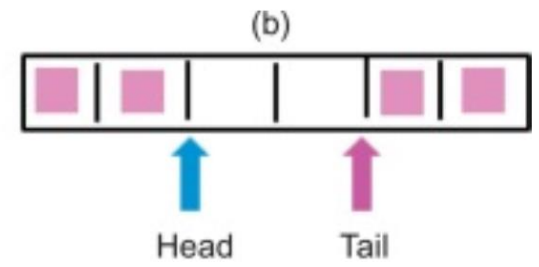
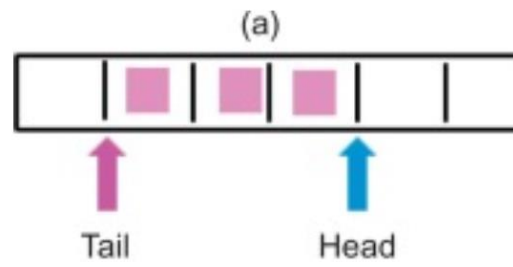
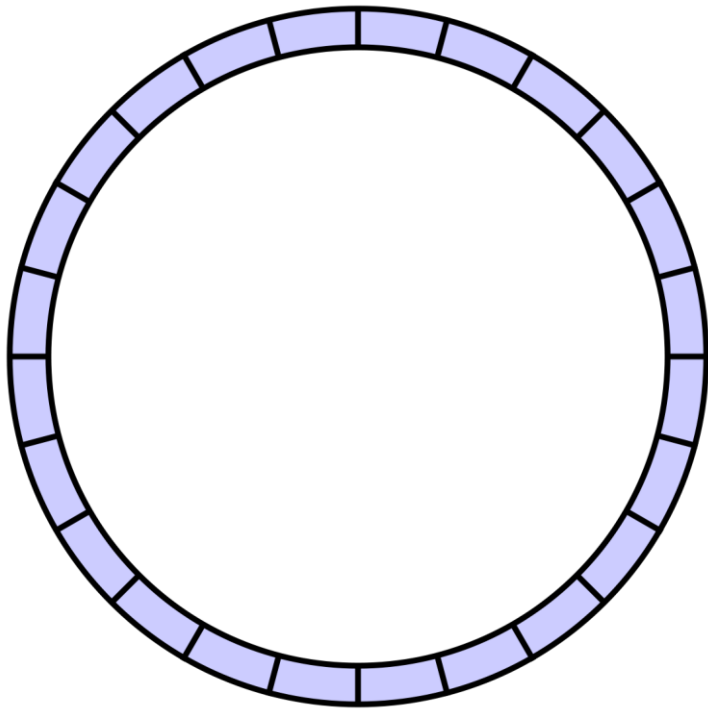

ANALOGY TIME



CIRCULAR BUFFER

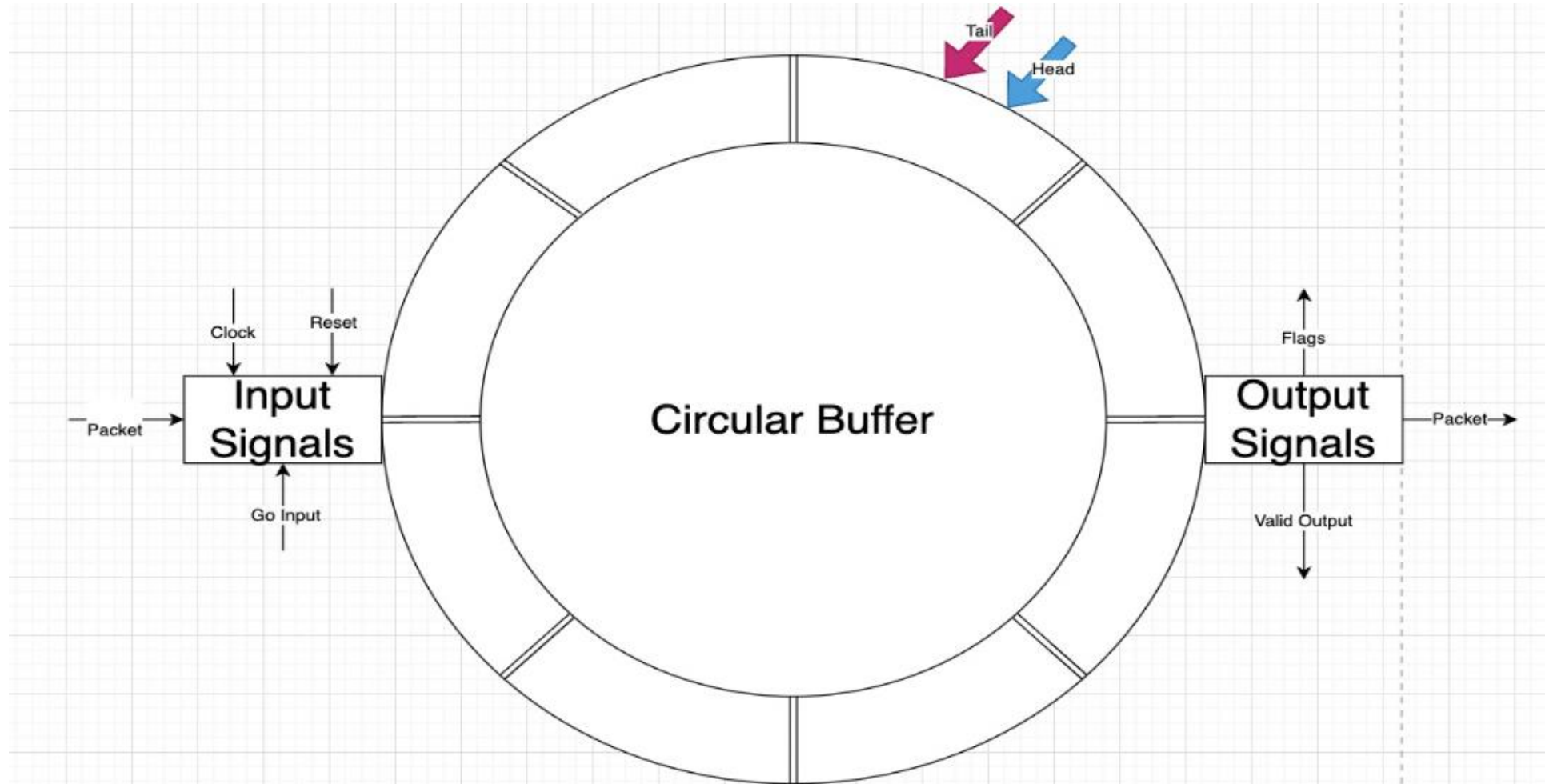

FINAL MODULE

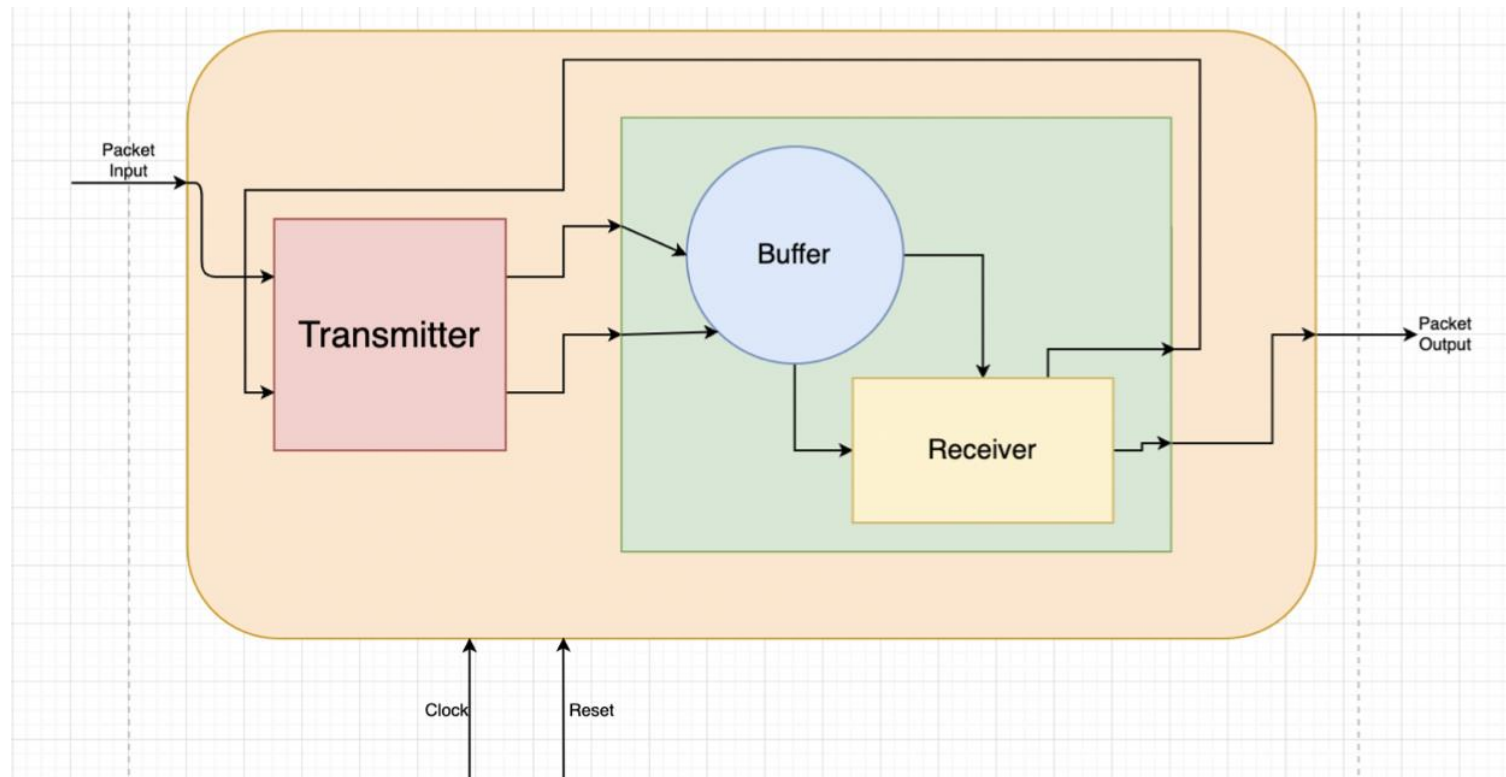

DETAILED MODULE

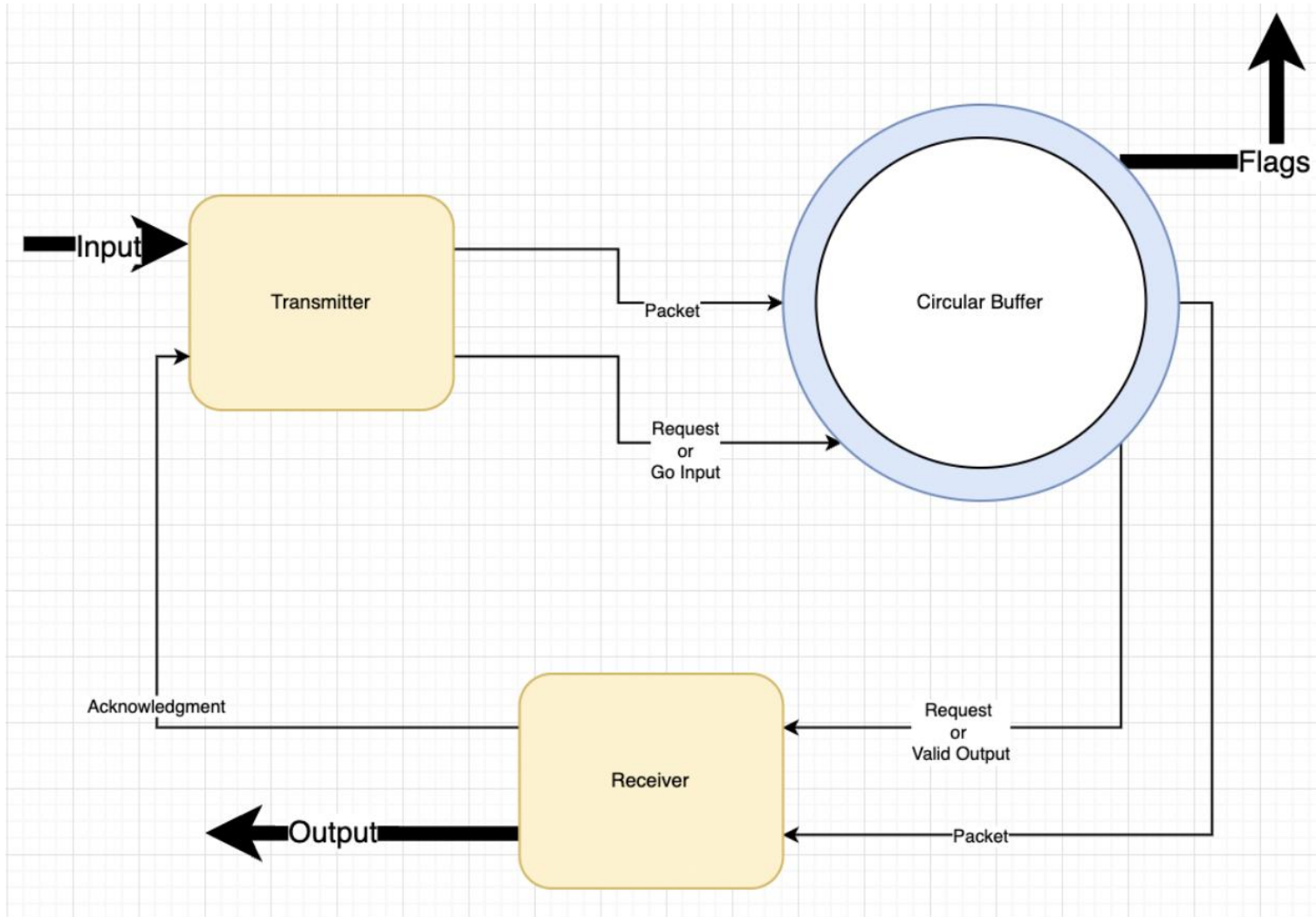

RESULTS

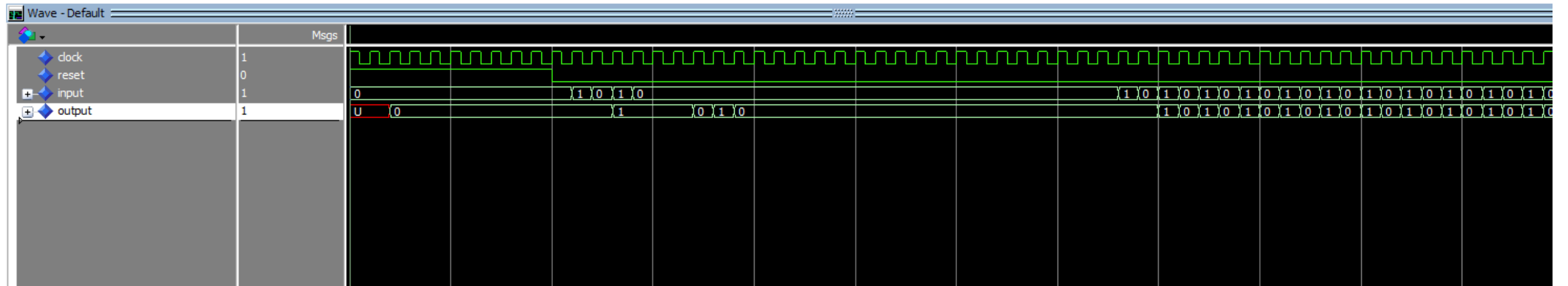



TO SUM EVERYTHING
UP